

Finished Molding Stack Diagram

Read carefully before you begin.

This kit contains pre-packaged molding pieces that complement each other in a pre-designed molding stack. Professional installation strongly recommended.

MS DSCVM8 100

Contents:

(1-ct) DSCVM8

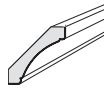

(2-ct) SBIM8

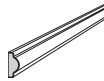

(1-ct) STRM8

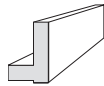

This molding stack can be installed at different heights. Reference Molding Stack Detail Drawing supplied by designer to confirm intended height.

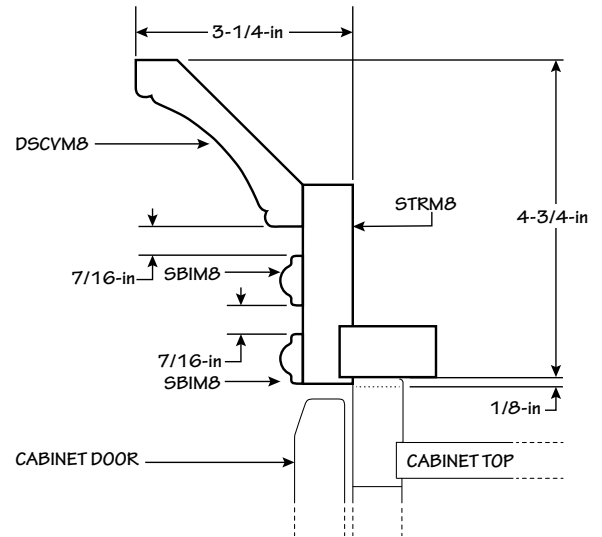

MS DSCVM8 200

Contents:

(1-ct) DSCVM8

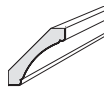

(1-ct) LBM8

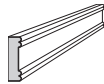

(2-ct) HWC 1X2X96
• Unfinished

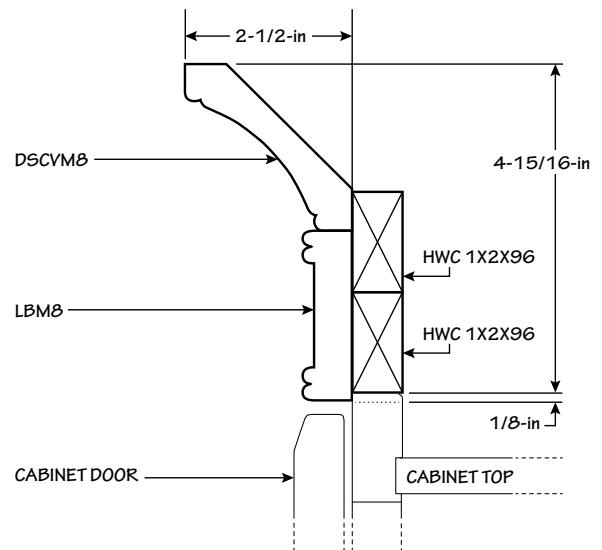
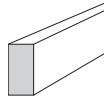

MS DSCVM8 300

Contents:

(1-ct) DSCVM8

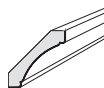

(1-ct) TBIM8

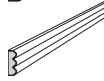

(1-ct) CLBM8

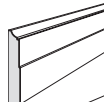

(1-ct) HWC 1X2X96
• Unfinished

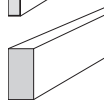

This molding stack can be installed at different heights. Reference Molding Stack Detail Drawing supplied by designer to confirm intended height.



Diagrama de Conjunto de Molduras de Acabado

Lea las instrucciones detenidamente antes de comenzar.

Este kit contiene piezas de molduras previamente empacadas que se complementan unas con otras en un conjunto de molduras previamente diseñadas. Se recomienda encarecidamente una instalación hecha por profesionales.

MS DSCVM8 100

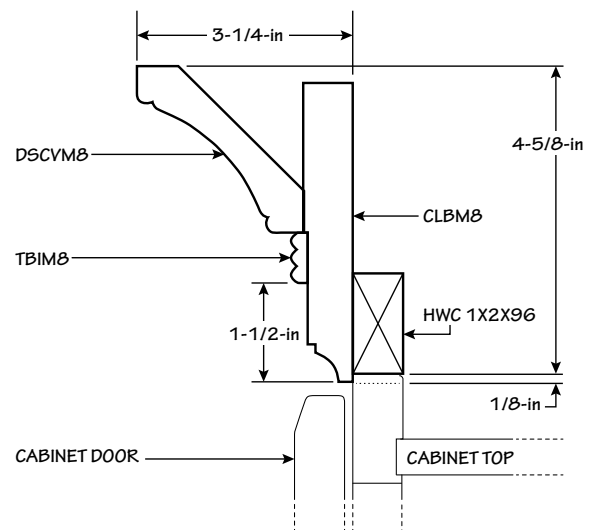
Contenido:

(1-ct) DSCVM8

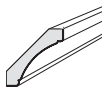

(2-ct) SBIM8

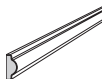

(1-ct) STRM8

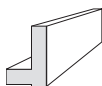

Este conjunto de molduras se puede instalar a diferentes alturas. Dibujo de referencia del conjunto de molduras provisto por el diseñador para confirmar la altura planeada.

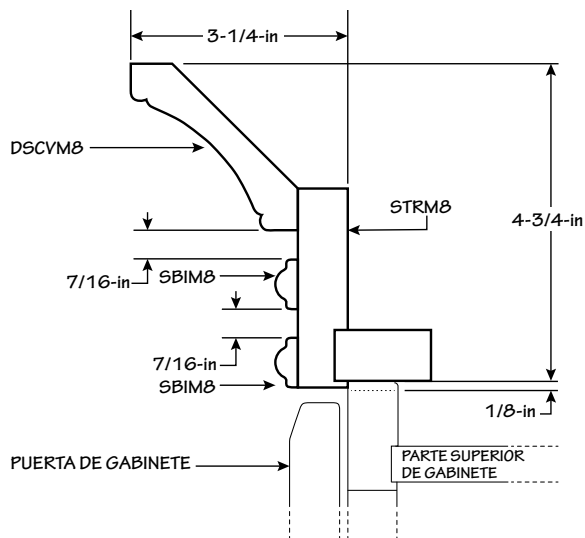

MS DSCVM8 200

Contenido:

(1-ct) DSCVM8

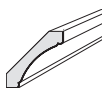

(1-ct) LBM8

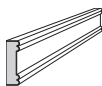

(2-ct) HWC 1X2X96
• Sin acabado

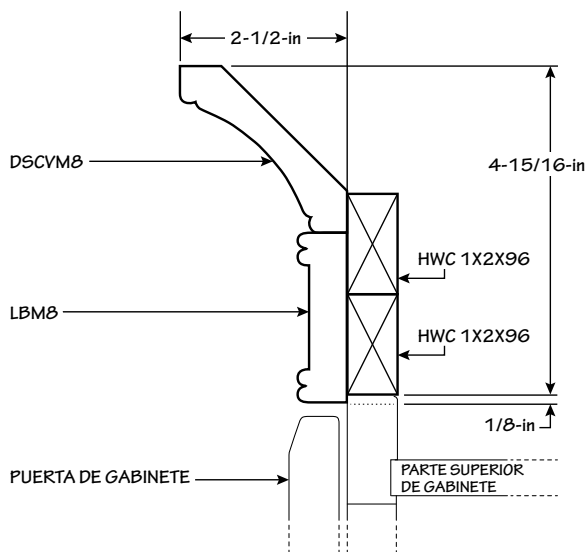
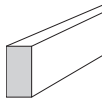

MS DSCVM8 300

Contenido:

(1-ct) DSCVM8

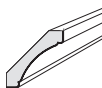

(1-ct) TBIM8

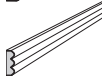

(1-ct) CLBM8

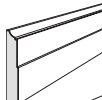

(1-ct) HWC 1X2X96
• Sin acabado

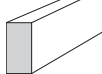

Este conjunto de molduras se puede instalar a diferentes alturas. Dibujo de referencia del conjunto de molduras provisto por el diseñador para confirmar la altura planeada.

